

Форма 3

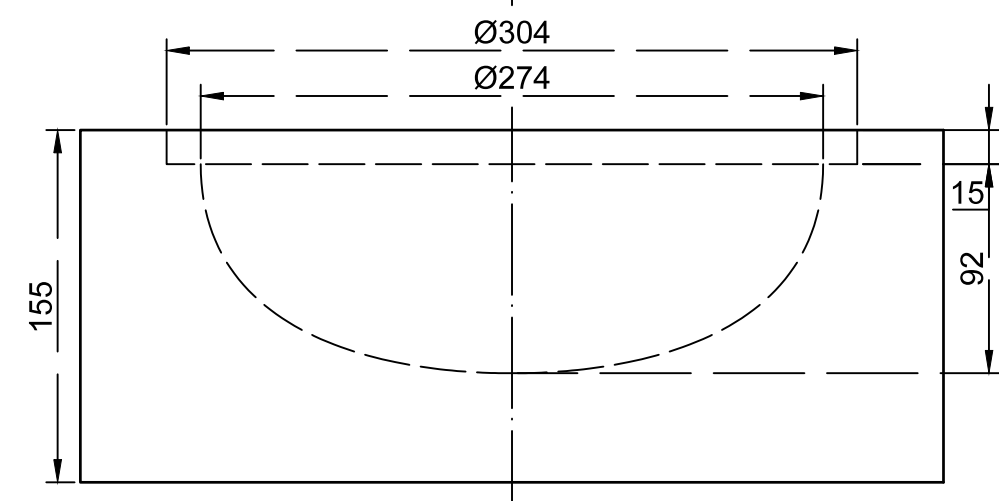

Форма 4

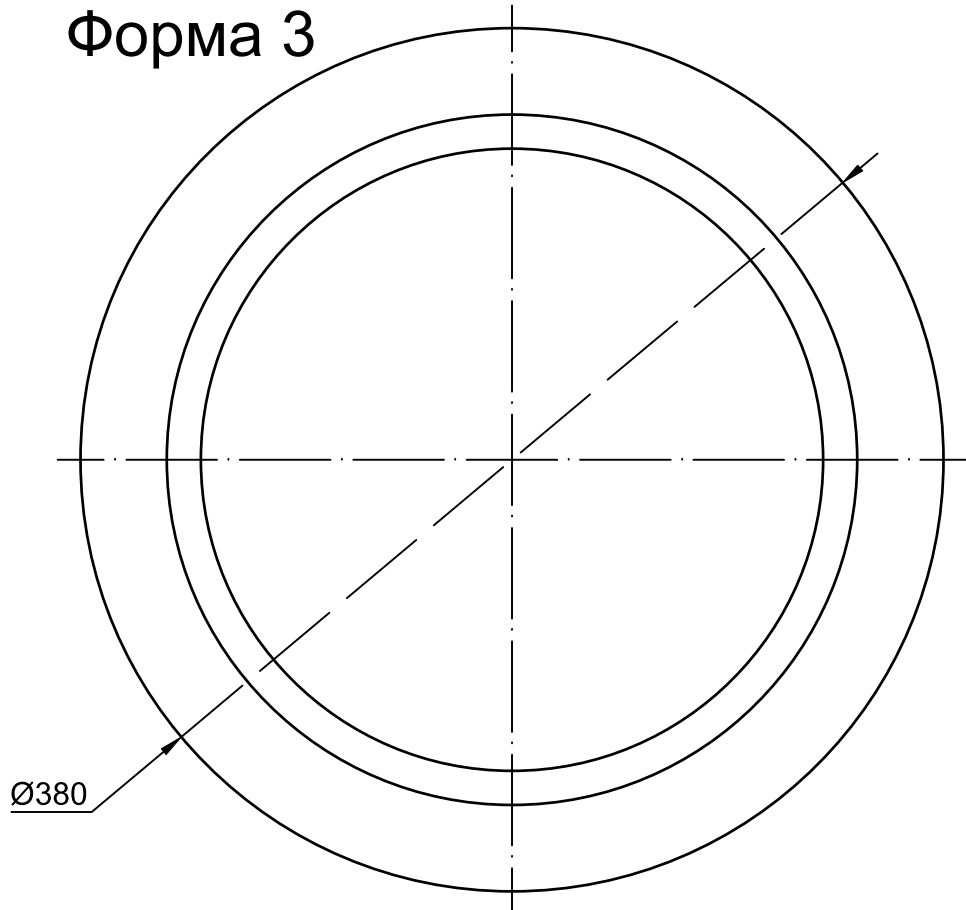