

Варианты изготовления лестницы

Вариант 1 1-1

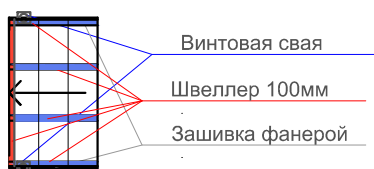

Вариант 2 1-1

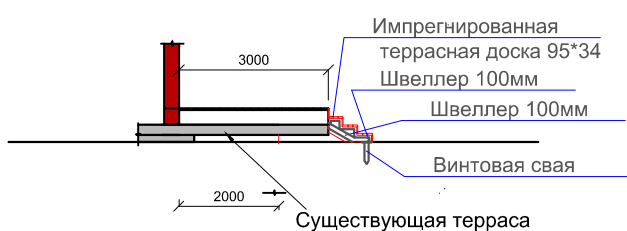
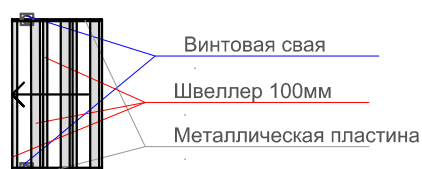
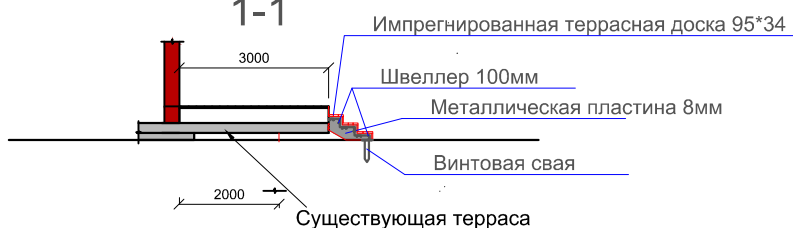

Вариант 1 2-2

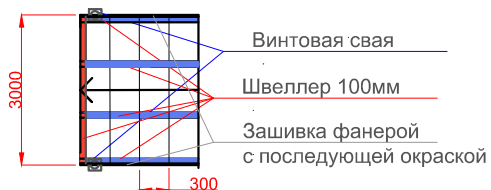
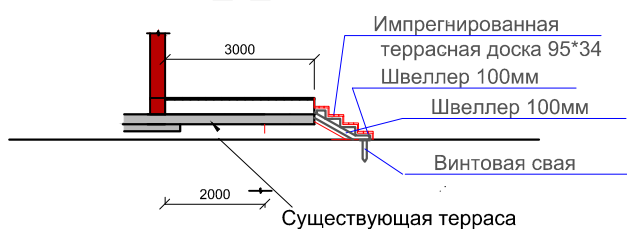

Вариант 2 2-2

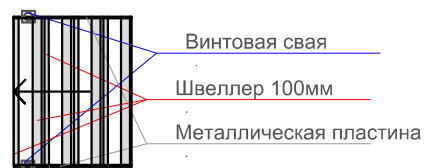
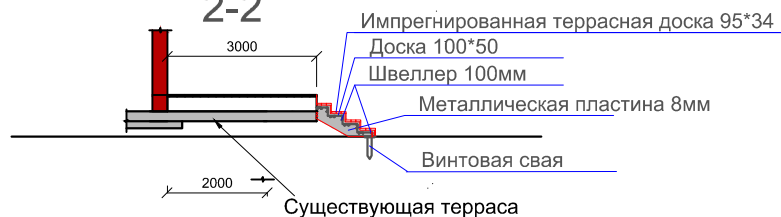

Принять высоту ступени от 160 до 170мм
ширина ступени 300мм

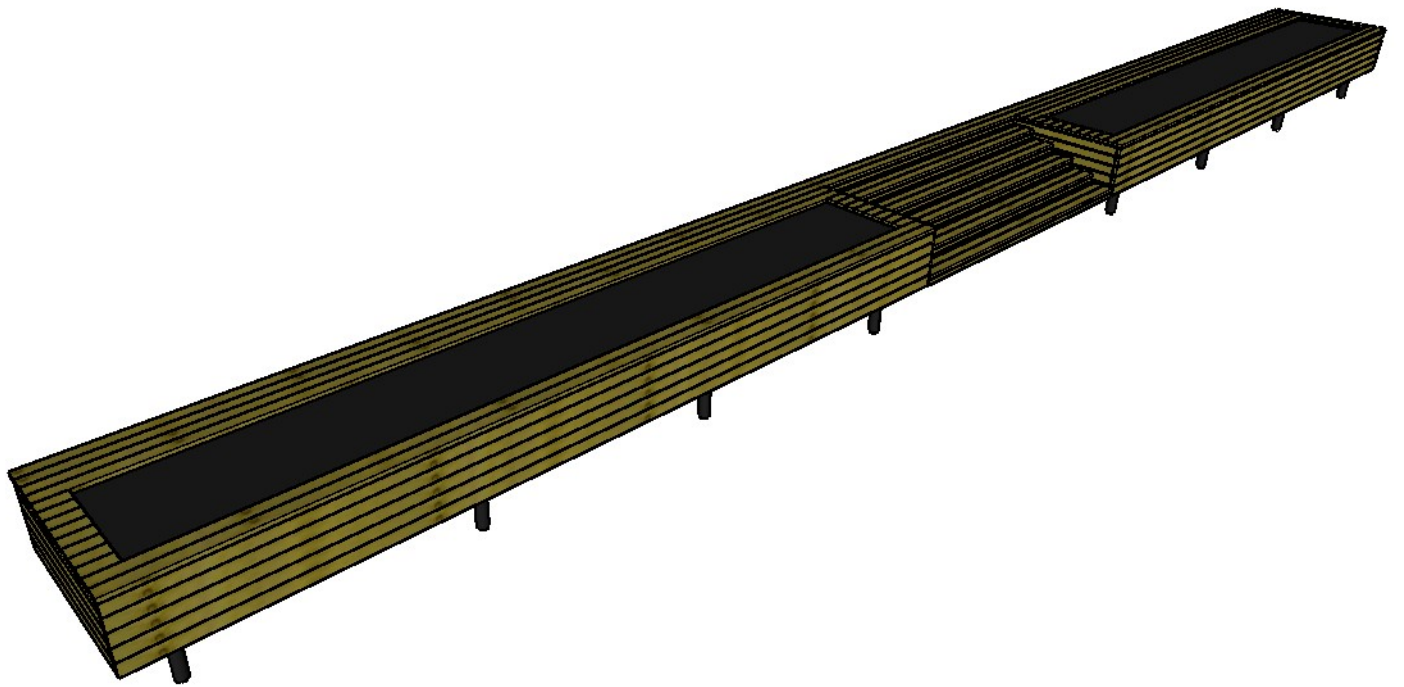

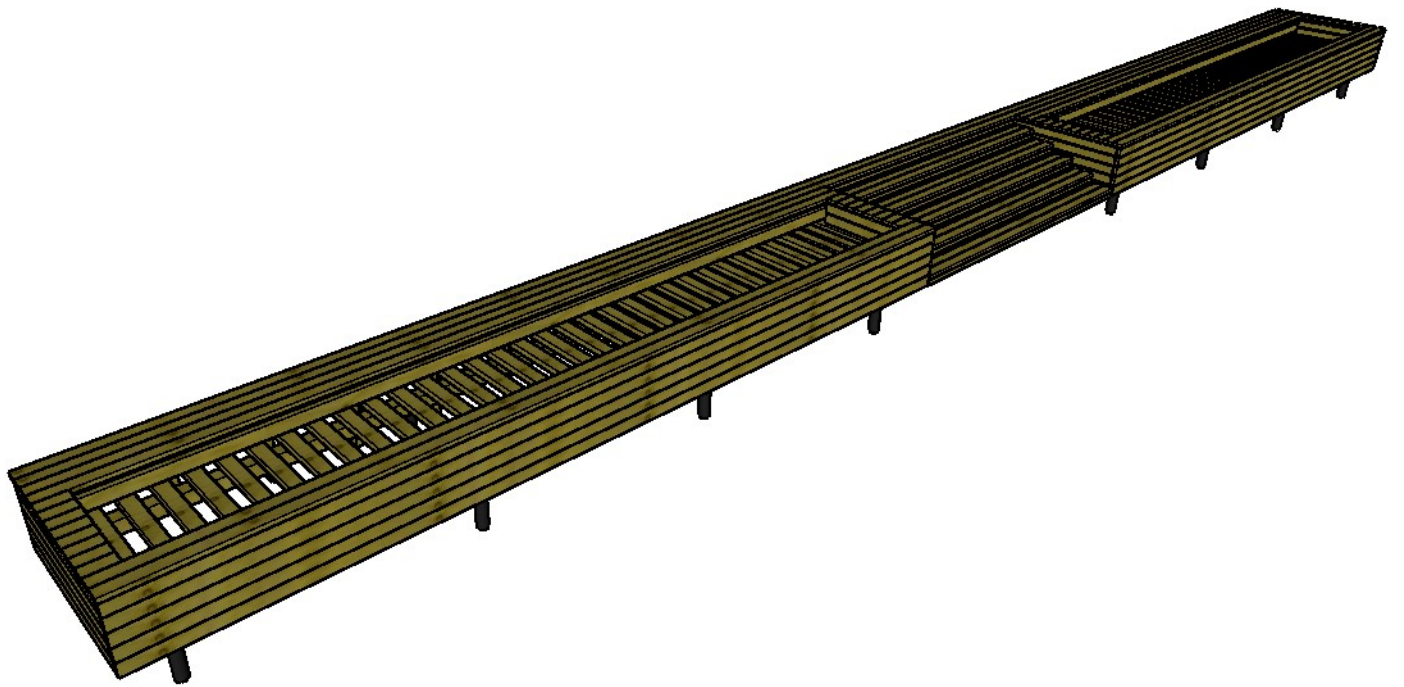

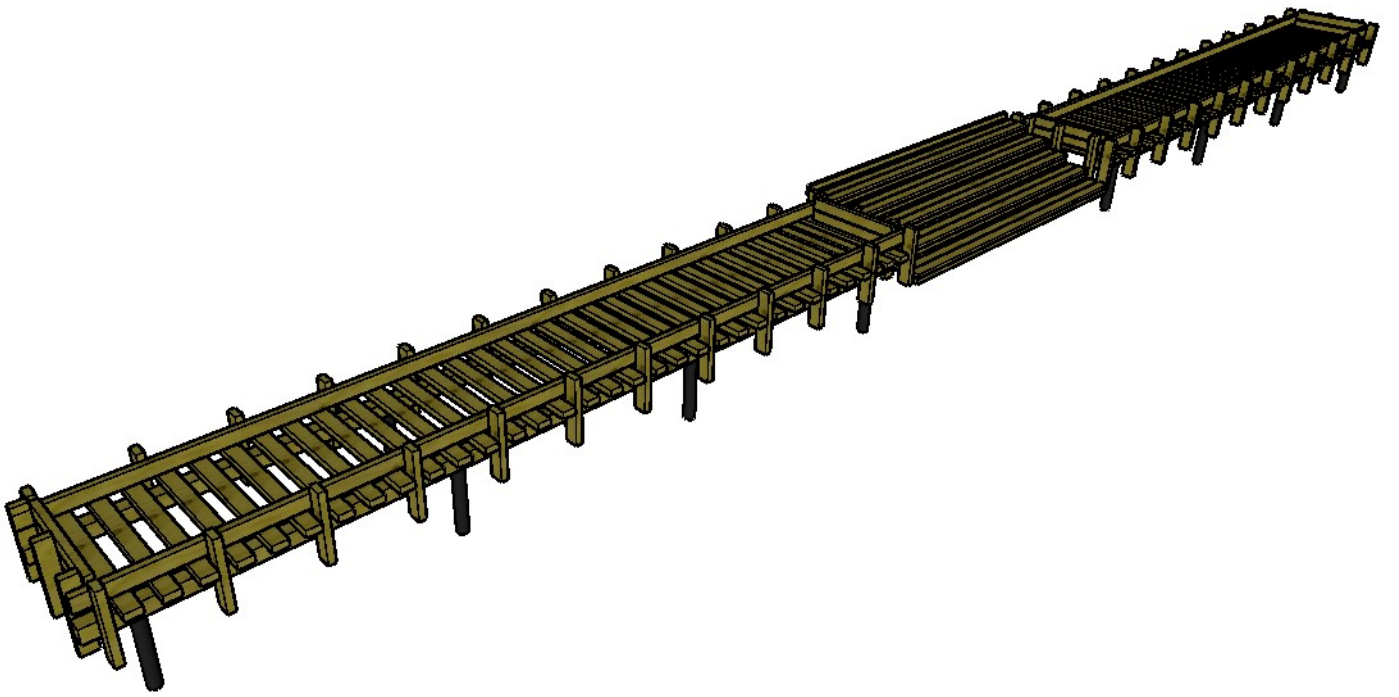

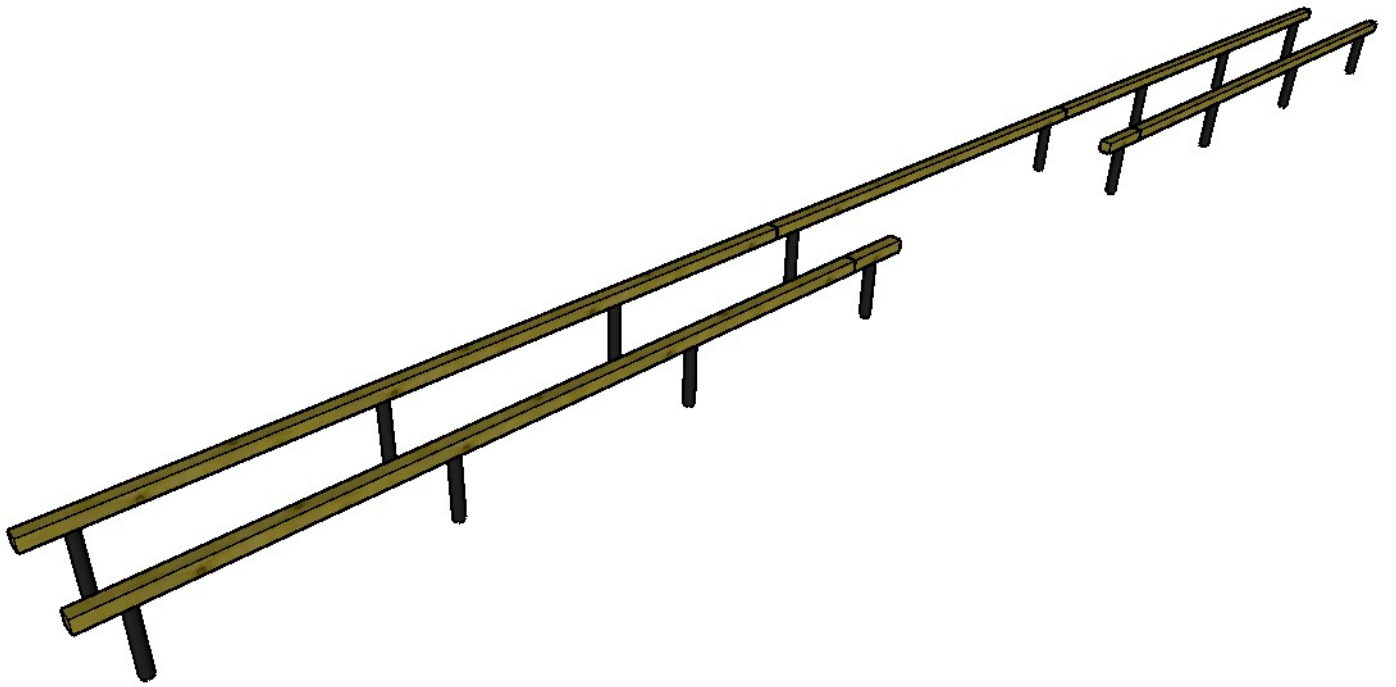

Тз на устройство клумбы

1-1

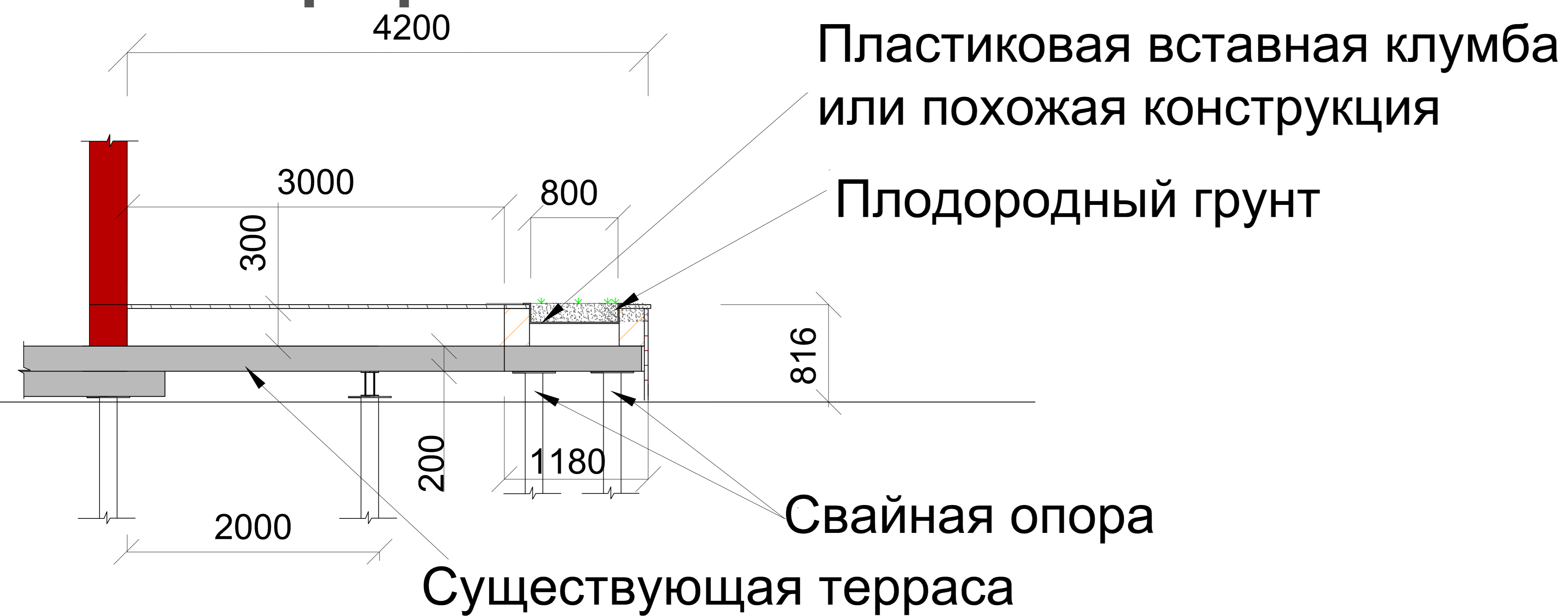

2-2

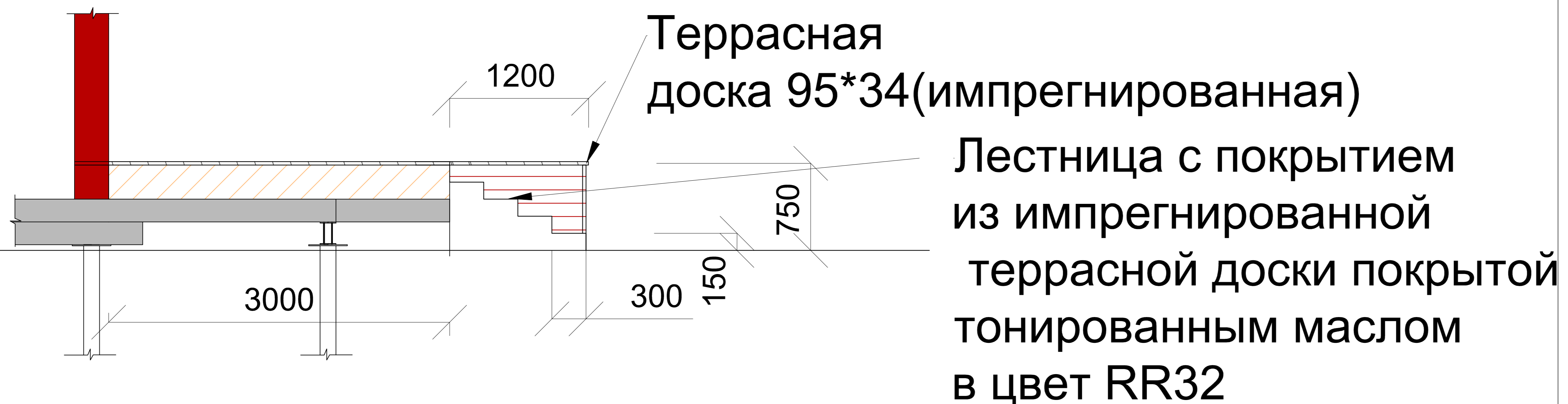

3-3

